

# **AUTOMATIC SKIMMER**

## **MODEL BS 111**



*Congratulations on purchasing a  
Pro-Series Automatic Skimmer*

# AUTOMATIC SKIMMER SYSTEM INCLUDES



**TOP COVER (1)**  
(BS 08710)



**SIMMER  
BODY (1)**  
(BS S111BD)

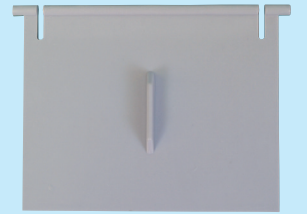

**SKIMMER WEIR (1)**  
(BS 68985)

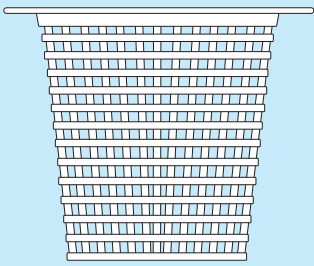

**STRAINER BASKET (1)**  
(BS 74489)

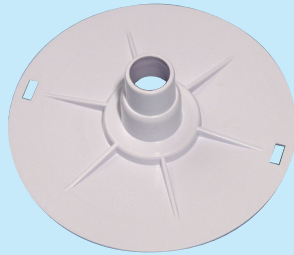

**VACUUM ADAPTER (1)**  
(BS 08370)

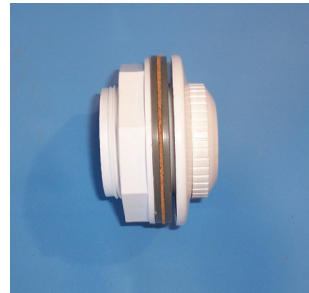

**RETURN FITTING (1)**  
(JT 37532)



**HOSE FITTINGS (2)**  
(BS 40061)

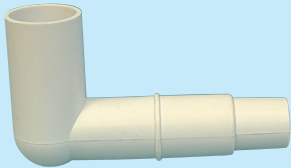

**VACUUM ELBOW (1)**  
(BS 74470)

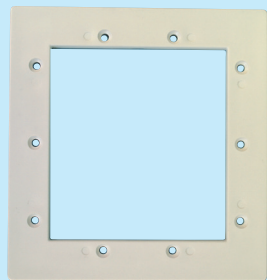

**FACE PLATE (1)**  
(BS 08354)

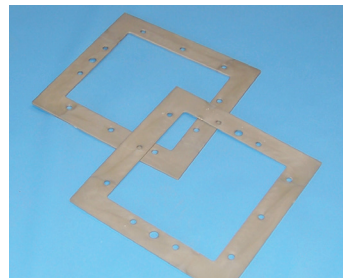

**PAIR GASKETS (1)**  
(JT 37435)



**SS CLAMPS (4)**  
(BS 35815)



**SKIMMER SCREWS  
(10 PK)**  
(JT 37575)

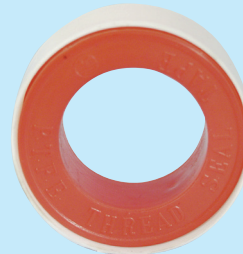

**TEFLON TAPE (1)**  
(BS 35858)

## OPTIONAL:

### TO COMPLETE YOUR AUTOMATIC SKIMMER AND FILTER INSTALLATION YOU WILL ALSO NEED THE FOLLOWING:

- 2 — 6 Ft Long Filter Hoses to connect the Skim Filter to the suction part of your pump and another to connect discharge port of YOUR PUMP to return fitting
- 1 — Pool Pump to circulate water through the Filter System



- Congratulations on your choice of a Blue Torrent Premium Skim System. We are confident that you too will discover why Blue Torrent products are unparalleled. Our decision to produce the finest quality products has allowed us to become leader in the pool industry.
- Blue Torrent Automatic Skimmer has been carefully designed to insure a perfect fit on all aboveground pools manufactured with the industry standard square skimmer cut out. If you have a wide mouth cut out in your pool wall you will require a Blue Torrent Wide Mouth Adapter available from your local Blue Torrent Pool Professional.

- Your Blue Torrent 111 is equipped with an extra large debris basket. The large capacity not only holds more debris than standard skimmer baskets it allows for a large reservoir of water in the skimmer.
- This eliminates a lot of strain on your filter pump and increases its efficiency. The extra large basket allows for the use of micro screen pre-filters. By installing micro-screens into your skimmer basket you can eliminate up to 50% of filter maintenance by trapping the fine debris BEFORE it gets into your filter.

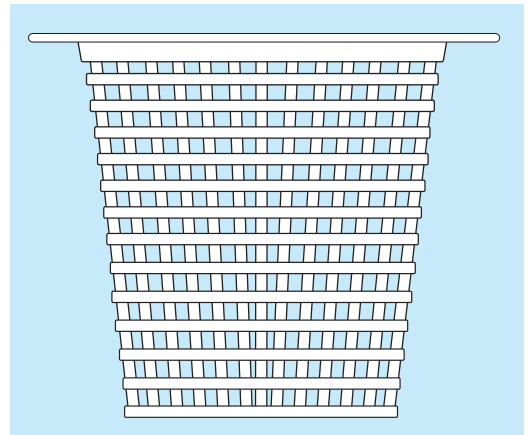

## STEP 1

- Review the parts you have with the parts listed on page 2. Verify each part and quantity.

## STEP 2

- Using a Phillips head screwdriver remove the 10 Stainless Steel screws from the Skim Filter faceplate. This will allow you to separate the FACE PLATE, SKIMMER GASKETS and STAINLESS STEEL SKIMMER SCREWS from the SKIMMER BODY. (If factory assembled)

## STEP 3

- Lower the water level in your pool. Since you are replacing both the skimmer and return you will need to lower the water until it is 2 inches below the return fitting.

## STEP 4

- If you have an existing skimmer and return, you will need to remove these prior to installation.
- For a new installation, make sure the skimmer knockout plate on the pool wall has been removed and the skimmer screw holes are open. In the event the skimmer knockout is still in place you will have to remove it. This can be accomplished by carefully peeling the knockout out of the wall using a pair of pliers. In some cases it may become necessary to use a hack saw to cut the metal tabs holding the knockout in place. In all cases care must be taken since the metal edges are extremely sharp. Consult your pool manufacturer instructions.

## STEP 5

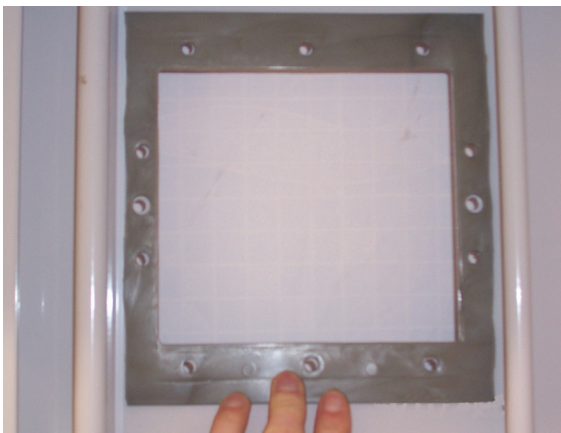

- Take one of the Skimmer Gaskets (JT 37435) and line it up with the holes on the outside of your pool wall. Secure the gasket to the outside of the wall by using two small pieces of cellophane tape. Secure the two top corners of the gasket to the pool wall with the tape.

## STEP 6

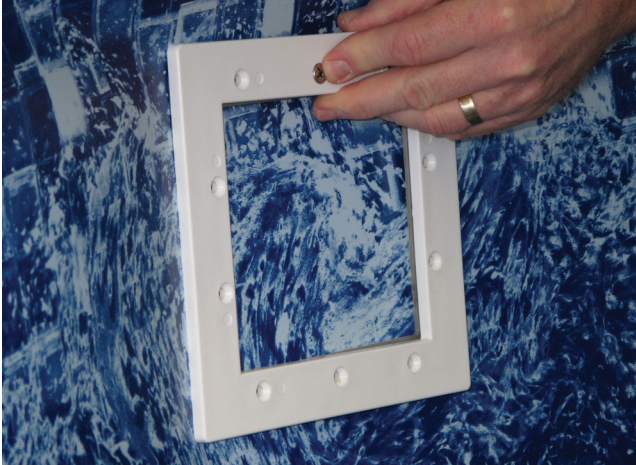

- Take the other skimmer gasket and the skimmer faceplate (BS 08354) and line them up so all holes match perfectly.

## STEP 7

- Take one of the stainless steel skimmer screws (JT 37575) and place it into the center top hole in the skimmer face plate.

## STEP 8

- On the inside of the pool, press the liner against the inside of the pool wall until you locate the hole in the wall that corresponds to the center hole in the skimmer faceplate.

## STEP 9

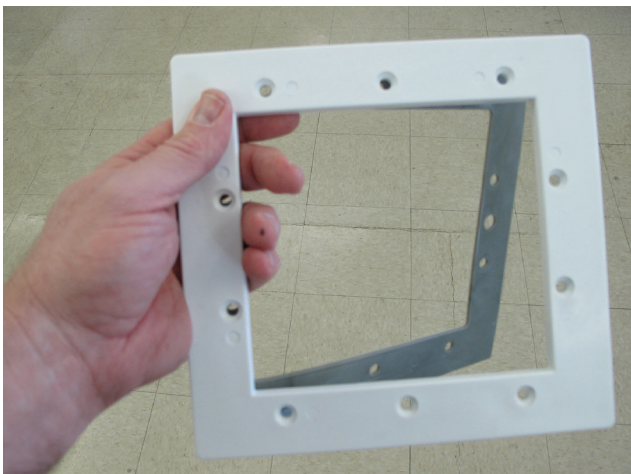

- Carefully insert the stainless steel skimmer screw that is already inserted into the faceplate into the corresponding center hole in the pool wall. You will have to **PUSH THE SCREW POINT THROUGH THE POOL LINER AT THIS POINT** .

## STEP 10

- Line up the skimmer faceplate and inside gasket with the knockout opening in the pool wall.

## STEP 11

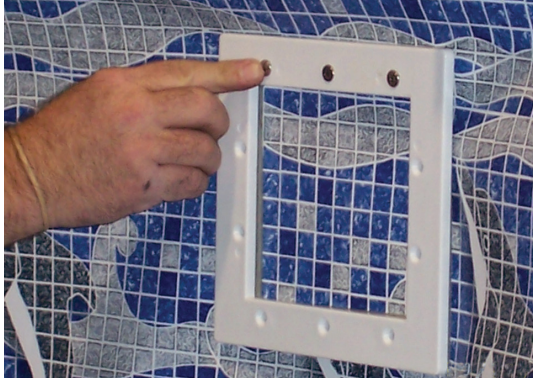

- One by one, push each stainless steel screw through the screw hole in the faceplate, inner gasket and pool wall until they are all in place.

## STEP 12

- Make sure the screws from the faceplate are through the pool wall and outside skimmer gasket.

## STEP 13

- Line up the skimmer body (BS S111BD) screw holes with the skimmer screws on the outside wall. This is done by angling the skimmer body away from the pool wall at the top and carefully lining up each screw point with the corresponding screw hole in the skimmer body.



## STEP 14

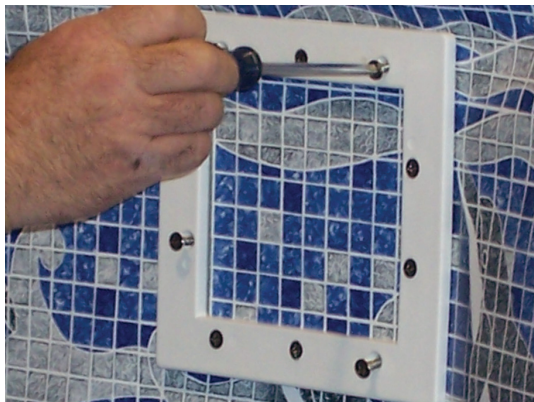

- While holding the skimmer body in place, tighten each of the skimmer screws using a Phillips head screwdriver. **DO NOT USE A DRILL OR SCREW GUN – THIS WILL DAMAGE THE SKIMMER BODY AND VOID YOUR WARRANTY.** Tighten each screw until they “catch” the skimmer body.

## STEP 15

- Hand tighten all the skimmer screws. Do this by giving each screw a full turn with a Phillips head screwdriver working your way around the faceplate one screw at a time. This will take longer than tightening each screw completely before going to the next but by tightening each screw one turn at a time you will ensure a complete gasket seal between your pool and the skim filter.

## STEP 16



- Once all the screws are hand tightened you should have 10 screws in place and the faceplate should be flush against the pool liner.
- Now that your skim filter body has been secured to your pool you can complete the installation.

## STEP 17

- Carefully cut the vinyl liner inside the face plate. Using a razor blade cut the liner as close to the edge of the skimmer opening. Be sure to use a new razor blade, old dull blades can cause the liner to pull giving you an uneven edge.

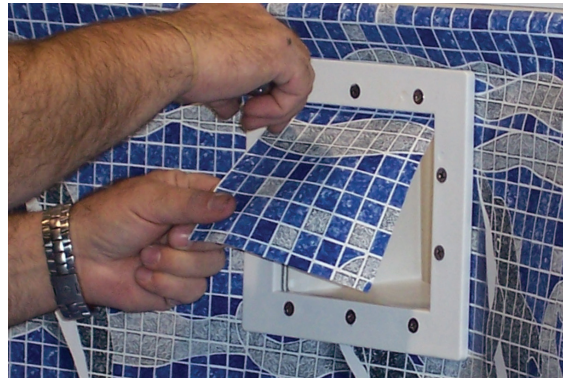

## STEP 18



- Use the Teflon tape provided (BS 35858) to cover all the threads on the hose fitting (BS 40061) Wrap the tape around the threads at least 10 wraps. The Teflon tape will prevent leakage from the fitting. Once the fitting is wrapped you can screw the fitting – threads facing up- into the bottom port of the skim filter body (BS S11BD).

## STEP 19

- Place the skimmer basket (BS 74489) into the skim filter over the cartridge. The basket will rest on the lip inside the skim filter.

## STEP 20

- Install the top cover (BS 08710) onto the skim filter. This is done by simply snapping the cover in place.

## STEP 21



- Install the skimmer weir door (BS 68985). From inside the pool take the skimmer weir door and snap the tabs of the weir into the corresponding holes on the inside of the skimmer opening. Place the weir foam side up with the tabs facing in toward the skimmer. Place the tab on the left side into the corresponding hole. Put pressure towards the left side of the weir and slide the right tab into the corresponding hole on the right side of the skimmer opening. Release the pressure and the weir door should swing freely in position.

## STEP 22

- Connecting the skim filter to your pool pump is accomplished by first attaching either a 1½" or 1¼" diameter hose to the hose fitting located at the base of the skim filter. The hose fitting (BS 40061) accepts both 1½" and 1¼" diameter hoses. Push the cuff of the hose up onto the hose fitting (halfway up for 1¼" hose, all the way for 1½" diameter hose) Secure the hose to the fitting using a Stainless Steel Clamp (BS 35815)



## STEP 23

- Connect the other end of the suction hose to the front (intake) port of your pump. Secure the hose using a stainless steel clamp provided.

## STEP 24



- Install the return fitting . Locate the return opening in your pool wall and push the pool liner against the inside of the wall so the liner is protruding outside the pool. CAREFULLY cut a small "x" in the liner where it lines up with the return opening in your pool wall.



## STEP 25

- Disassemble the return assembly (JT 37532) so you have just the inside port and one of the rubber return gaskets. Place the rubber return gasket over the threaded part of the return port.



## STEP 26



- From inside the pool, push the threaded part of the return port through the liner opening and the return opening in your pool wall.

## STEP 27

- From outside the pool, place the second RUBBER return gasket onto the threaded part of the return fittings so it touches the outside of the pool wall. Then take the CORK return gasket and place it over the rubber gasket so it DOES NOT TOUCH THE POOL WALL.



## STEP 28



- Take the return locknut and screw it onto the threads of the return fitting from outside the pool. Be sure to have the FLAT side of the nut facing the pool. Using a channel lock pliers, hand tighten the nut.

## STEP 29



- Take the remaining hose fitting (BS 40061) and wrap the threads with Teflon tape. Again wrap the threads approximately 10 times to eliminate leaks.

## STEP 30

- Thread the fitting into the outside opening of the return fitting. Use a channel lock to get a tight fit.



## STEP 31

- Attach the discharge port of your pump to the return port fitting using a 1 ¼” or 1 ½” diameter hose. Connect one end of the hose to the discharge port of your pump and secure the hose using one of the stainless steel clamps provided. Attach the other end of the hose to the hose fitting attached to the outside of the return using the last of the stainless steel clamps provided.

## STEP 32

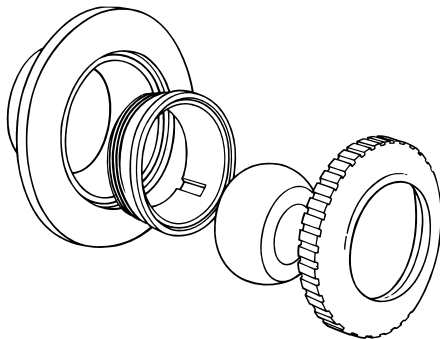

- From inside the pool, screw the ball seat, eyeball and ring into the return port. The ball seat holds the eyeball in place and allows it to pivot, the ring secures it to the return. Your Blue Seal® Skim Filter comes with assorted directional eyeballs so you can customize the return flow for your pool.

## STEP 33

- Begin filling your pool. For best results only add up to 12 inches of water per day and do so when the sun is shining on the pool liner. The sunlight will increase the liners pliability and eliminate wrinkles from the liner pulling on the skimmer and return openings. Continue filling your pool until the water level fills ¾ of the skimmer opening (the upper side screw head on the skimmer plate).

## STEP 34

- Place the filter cartridge into the skim-filter body . With the handles facing up, insert the cartridge into the skim- filter body. The port on the bottom of the cartridge will fit snugly into the base of the skim filter. Once it is inserted, with a twisting motion push the cartridge all the way down into the skimmer body.

## VACUUMING PROCEDURE

When it is necessary to vacuum your pool, please follow the guidelines listed below in order to ensure proper suction and successful vacuuming.

1. Make sure that you have a vacuum head with handle, telescopic pole and vacuum hose that is at least 6' longer than your pool (all sold separately).  
**NOTE:** If your pool is 18' round, your hose should be at least 24' long  
**NOTE:** If your pool is 12' x 24' oval, your hose should be at least 30' long
2. You will need your Vacuum Plate and Vacuum Elbow to hook up your vacuum.
3. Make sure that your Skimmer Basket is clean inside the skimmer.
4. Attach swivel cuff of vacuum hose onto vacuum head. Attach telescopic pole to vacuum handle and place into bottom of pool.
5. Take the loose end of the hose and bring it to the return underneath the water level with the filter running. The vacuum head will float up as air is forced from the hose. Once the vacuum head has stopped moving and the air bubbles have stopped, all the air is out. This procedure is called priming the hose.
6. Remove top cover of skimmer and place vacuum plate over the Skimmer Basket with holes aligned over plastic tabs.

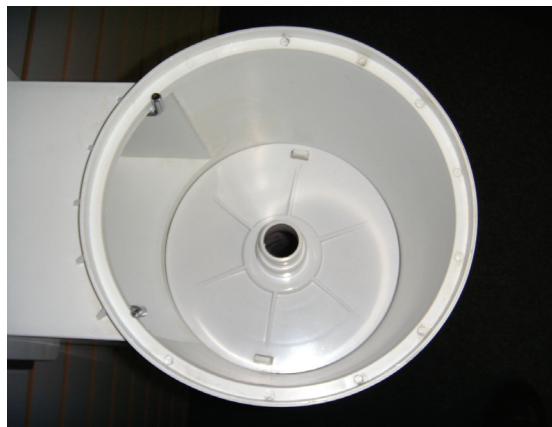
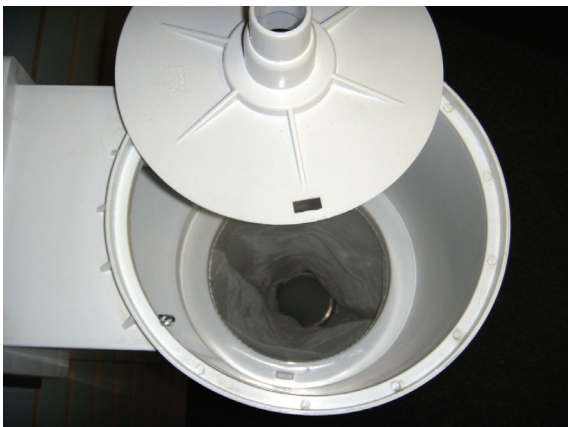

**Vacuum Plate going onto Skimmer Plate**

## VACUUMING PROCEDURE — CONTINUED

7. Place vacuum elbow with fat side over top of vacuum plate and make sure the longer side is pointing into the pool (see figure 2).



Facing into Skimmer opening towards pool

Figure 2 - Vacuum Plate & Elbow on basket

8. Move primed vacuum hose under water level from the return to the skimmer as the filter continues to run. **DO NOT** bring hose over water level as hose will fill with air.
9. Push weir door down flat into pool so that it does not interfere with vacuuming (see figure 3).



Figure 3 - Positioning weir for vacuuming

10. Place hose onto vacuum elbow through skimmer opening keeping hose underwater. If you were to look through the outside of the skimmer, it should look as figure 4 does.



Figure 4 - Inside look at elbow on plate and attached hose

11. You are now ready to vacuum. Remember to keep vacuum underneath water line at all times. Failure to do so will result in the need to re-prime the hose and start over. Breaking the water level allows air to enter the hose and affects your suction.
12. After vacuuming you should remove and clean your Skimmer Basket to prevent sluggish return flow.

## HELPFUL HINTS

- Always apply 1 qt. of Liquid Magnet (mineral remover) per 10,000 gallons pool water when adding more than 4" of fresh water to your pool. Liquid Magnet will remove minerals, which can permanently damage your element.
- Always remove element when adding chemicals through your skimmer (i.e. Blue Seal® Green Out shock treatment, Chlor-No-More sanitizing orb, Old Man Winter Orb & Blue Seal® Quick Tabs chlorine or Gold Dust chlorine).
- Never place slow dissolving chlorine tabs (i.e. Jumbo Slow Tabs, Slow Tabs or Slow Poke Sticks) in skimmer. These are acidic and can weaken your skimmer basket, body and element as well as cause corrosion of metal pump parts. Always use slow dissolving chlorine in an automatic chlorinator or floater.



# **BLUE TORRENT AUTOMATIC SKIMMER**

## **Model: BS 111 ONE YEAR LIMITED WARRANTY**

**One year limited warranty from date of purchase.**

**The BS 111** Skimmer System is guaranteed to be free of manufacturers defects in material and workmanship under normal use in accordance with the proper installation and operation manual.

**This Warranty** does not cover the following: Damage due to freezing caused by or related to improper drainage, winterization, or storage. Damage or failures arising from use of the product which does not comply with the instructions provided in this manual.

**This Warranty** is in lieu of all other express warranties. Replacement of defective products as provided under this warranty is your exclusive remedy. The manufacturer will not be liable in contract or tort for any direct, consequential, special, or incidental loss or damage arising out of the use or inability to use this product.

### **WARRANTY COVERAGE**

**1st Year** — 100% coverage against any manufacturers defects.

**ALL WARRANTY CLAIMS MUST BE HANDLED DIRECTLY WITH THE DEALER WHERE THE PRODUCT WAS PURCHASED. A SALES RECEIPT IS REQUIRED TO VERIFY PROOF OF PURCHASE**